

Soft Cells Lowtone

version 2021.07.13

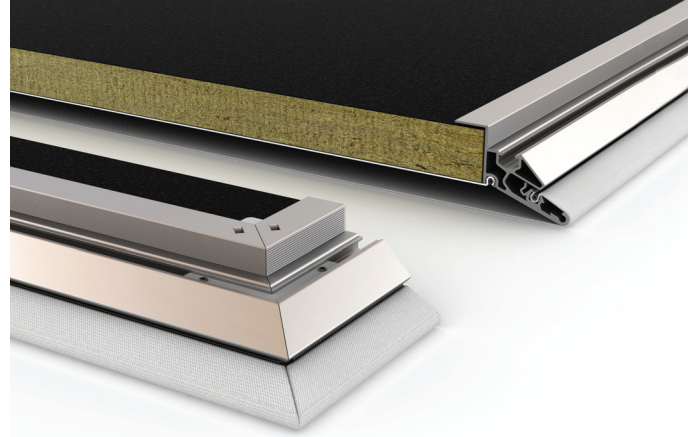

About

Soft Cells Lowtone panels have a specially developed glass textile membrane behind a tensioned front textile layer, and deliver excellent acoustic performance concentrated in the low and mid range frequencies – from 125 Hz upwards.

Particularly well suited to:

Spaces with special acoustic requirements not just sound absorption

Small rooms or spaces with large free surfaces for combination with other types of Soft Cells

Low frequency absorption and high frequency reflection

Applications

Interior walls and ceilings

Structural form

Single-sided, single-layer tensioned textile on aluminum frame with a specially developed porous glass textile on top of mineral-based acoustic core

Dimensions

Customized as standard from 7.87 × 7.87 in to 118.11 × 236.22 in, depending on choice of textile (textile width – 7.87 in = maximum panel width). Larger special sizes can be prepared on request

System depth

Wall-mounted version: 2.16 in from installation surface

Ceiling-mounted version with magnets or hinge/push-latch: 2.16 in from installation surface

Ceiling-mounted version with steel wire: min. 4.33 in/max. 62.99 in

Frame profile

Aluminum hollow section profile, height: 1.93 in
Colour: silver anodized

Mounting system

Walls: magnets and flex magnet (combined) or hinge/push latch

Ceilings: magnets or flex magnet or hinge/push-latch or steel wire

Textile

A standard set of textiles have been tested for sound absorption according to ISO 11654/EN ISO 354. Additional textiles can be tested for acoustic performance upon request

Acoustic core

Porous glass textile on top of 1.50 in mineral-based absorber incorporated 0.47 in air space behind front textile.

Accessories

Magnet suspension

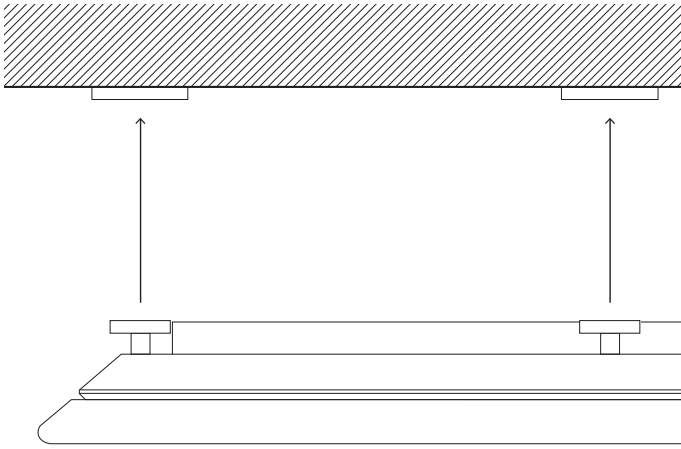

Allow for the dismantling of panels without tools.
Suitable for mounting on walls and ceilings

Material: pot magnet, steel

Overall depth of the panels from the face of the installation surface: 2.16 in

Steel wire suspension

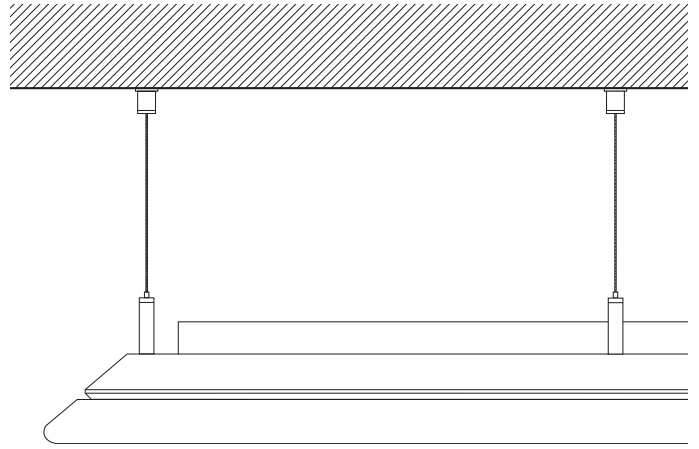

For ceiling mounting where a suspended ceiling is required.

Material: stainless steel wire

Adjustable distance from the front side of the panel to the installation surface: range: 4.33-62.99 in

Hinge/push latch suspension

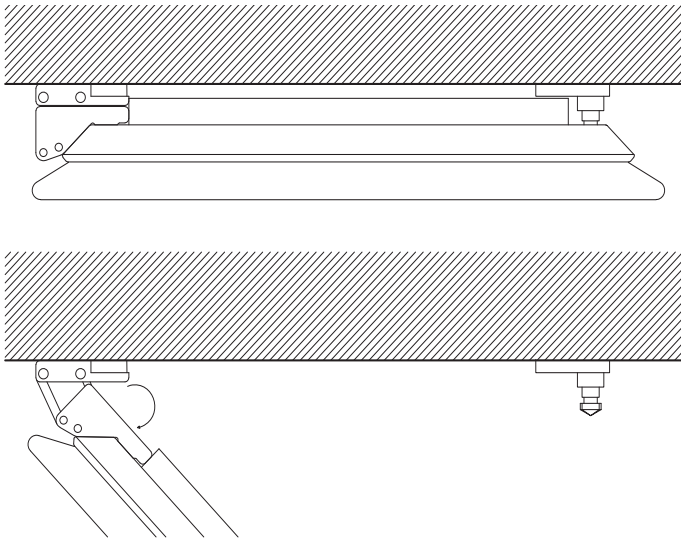

If subsequent access is required behind the panel, Soft Cells should in ceilings be mounted with hinge/push latch.

Material: steel

Dimensions from the front side of the Soft Cells to the installation brackets: 2.16 in

Flex magnet suspension

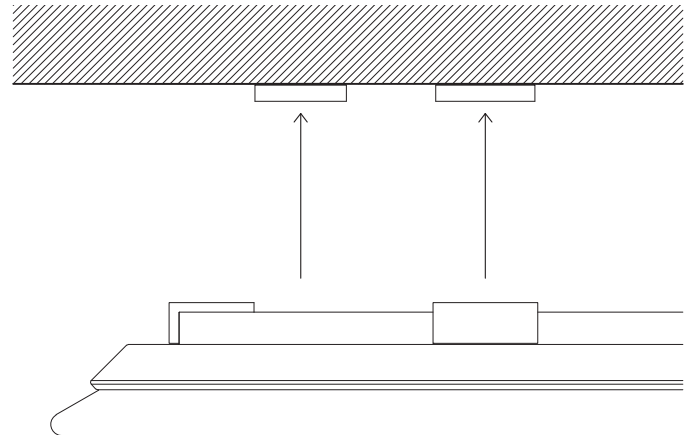

Allow for the dismantling of panels without tools.
Suitable for mounting on walls and ceilings
Concealed/hidden solution.

Material: pot magnet, steel, aluminum

Overall depth of the panels from the face of the installation surface: 2.16 in

Safety wire

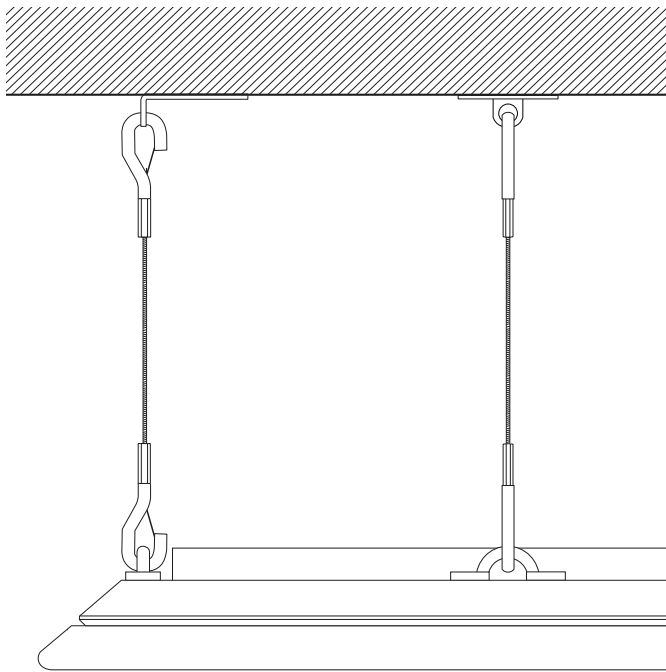

All suspension systems include safety wires if panels are installed in ceilings or on walls more than 118.11 in above floor level. (optional for wire suspension).

Fire performance

Kvadrat Soft Cells come with a range of fire tests classifications and certificates included as standard for several international markets (Europe, USA, China, Middle East, etc.). Due to the many different possible configurations of Soft Cells and varying fire regulations in different markets, the standard coverage can vary for your particular product choice and setting.

For further details please see Kvadrat Soft Cells fire performance, test certificates and services-document.

CE-marking

Kvadrat Soft Cells comply with the EU-harmonized product standard for suspended ceilings (EN-13964).

For further details please refer to softcells.com

End caps



Front view End cap profile

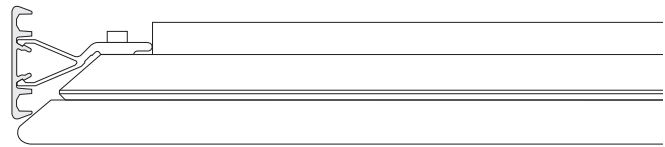

Side view End cap profile

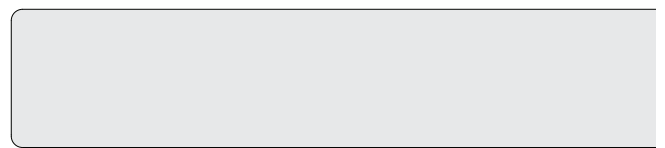

Front view Closed edge profile

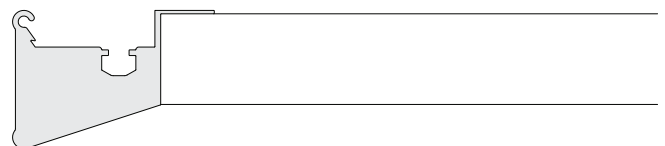

Section view Closed edge profile

For covering the small gap between wall and Soft Cells

Material: aluminum

Width: 1.77 in, length adjusted to length or width of Soft Cells, max.236.22 in in one piece. Can be upholstered with the same textiles as the Soft Cells panels.

Environmental labelling

Kvadrat Soft Cells carry general environmental product declaration (EPD) according to international standards. This information feed into all major environmental building certification schemes like DGNB, LEED, BREEAM, HQE and others used worldwide. Furthermore, Kvadrat Soft Cells are designed for disassembly.

Printed SC

SC with print is available on Primus 1100 and Toto 1102 as a front textile.

Printed textiles are EN-fire tested B,s1-d0 and acoustic performance equals non-printed versions.

Printed SC size limits are:

Max length of 118.11 in

Max width of 59.05 in.

Acoustic performance

Acoustic results for specific textiles can be supplied upon request, or downloaded from soft-cells.com.

See indicative example in figures below:

Wall Use

Wall and ceiling absorbers installed with magnets, 2.16 in depth (ISO-354) with different front textiles

■ Ginger 2 ■ Toto ■ Casa ■ Pro 3
■ Casita ■ Memory 2

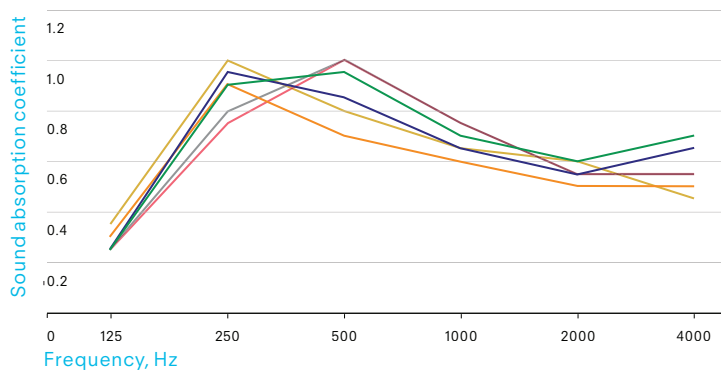

Ceiling Use

Suspended ceiling absorbers, 7.87 in depth (ISO-354) with different front textiles

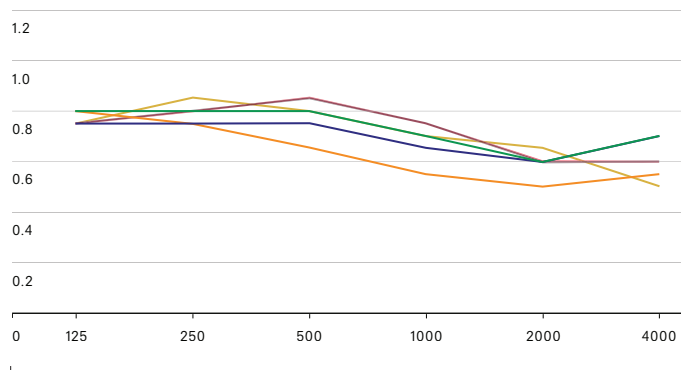

Textile example	Acoustic Class	NRC	US Fire Class
Ginger 2	C	0,8	Class A
Toto SC	C	0,8	Class A
Casa	C	0,8	Class A
Pro 3	C	0,75	Class A
Casita	C	0,8	Class A
Memory 2	C	0,65	Class A

Textile example	Acoustic Class	NRC	US Fire Class
Ginger 2	C	0,75	Class A
Toto SC	C	0,8	Class A
Casa	C	0,7	Class A
Pro 3	C	0,7	Class A
Casita	C	0,75	Class A
Memory	D	0,6	Class A