

Soft Cells Broadline

version 2021.07.13

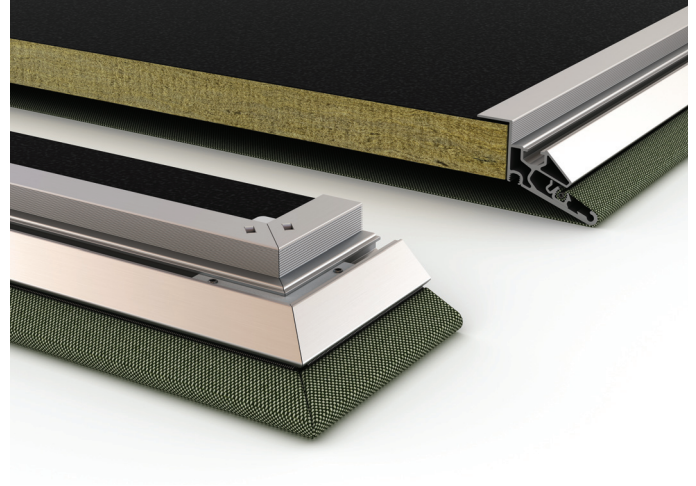

About

Soft Cells Broadline panels incorporate acoustic padding behind a textile layer. Typically, this model offers Class-A broad sound absorption, as per ISO 11654.

Particularly well suited to:

Spaces with severe to moderate sound reverberation problems and noise

Spaces with limited free wall or ceiling surface for acoustic regulation

Effective broadband absorption lowering overall reverberation

Applications

Interior walls and ceilings

Structural form

Single-sided, single-layer tensioned textile with a 40 mm thick acoustic padding core

Dimensions

Customised as standard from 200 × 200 mm to 3000 × 6000 mm, depending on choice of textile (textile width – 200 mm = maximum panel width). Larger special sizes can be prepared on request

System depth

Wall-mounted version: 55 mm from installation surface

Ceiling-mounted version with magnets or hinge/push-latch: 55 mm from installation surface

Ceiling-mounted version with steel wire: min. 110 mm/max. 1600 mm

Frame

Aluminium hollow section profile, height: 49 mm
Colour: silver anodised

Mounting system

Walls: magnets and flex magnet (combined) or hinge/push-latch

Ceilings: magnets or flex magnet or hinge/push-latch or steel wire

Textiles

A standard set of textiles have been tested for sound absorption according to ISO 11654/EN ISO 354. Additional textiles can be tested for acoustic performance upon request

Acoustic core

38 mm mineral-based absorber incorporated 12 mm air space behind front textile

Accessories

Magnet suspension

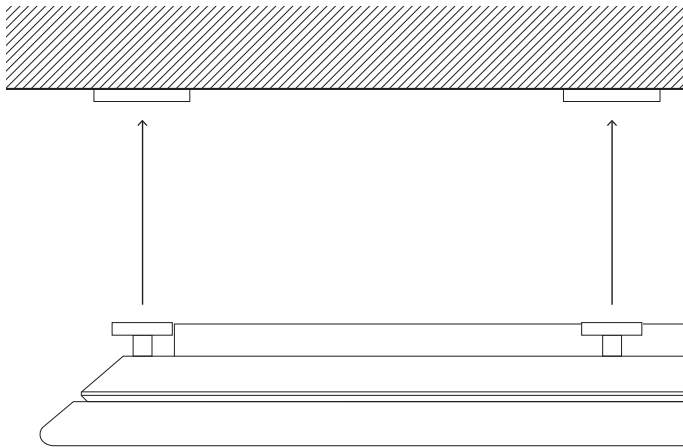

Allow for the dismantling of panels without tools.
Suitable for mounting on ceilings.

Material: pot magnet, steel

Overall depth of the panels from the face of the installation surface: 55 mm

Steel wire suspension

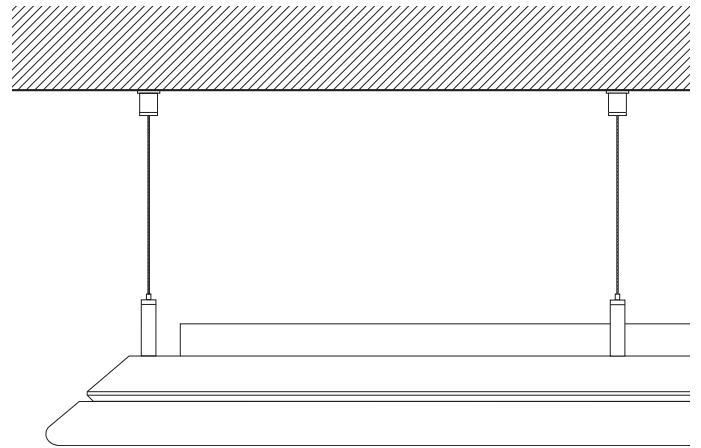

For ceiling mounting where a suspended ceiling is required.

Material: stainless steel wire

Adjustable distance from the front side of the panel to the installation surface: range: 110-1600 mm

Hinge/push latch suspension

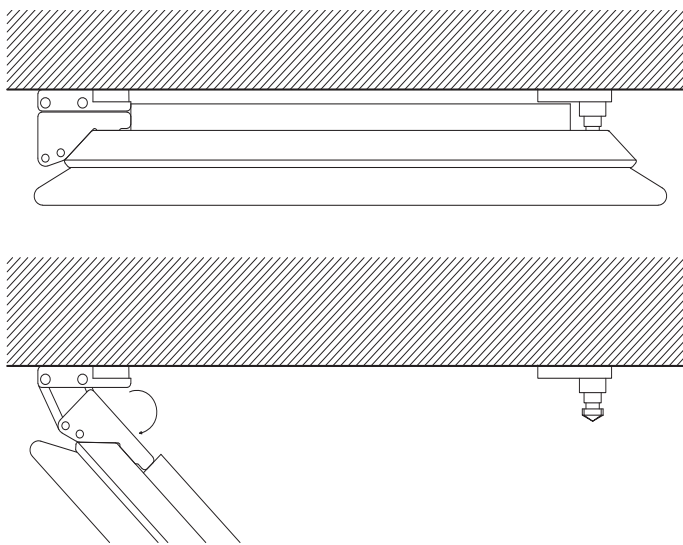

If subsequent access is required behind the panel, Soft Cells should be mounted with hinge/push latch.

Material: steel

Dimensions from the front side of the Soft Cells to the installation brackets: 55 mm

Flex magnet suspension

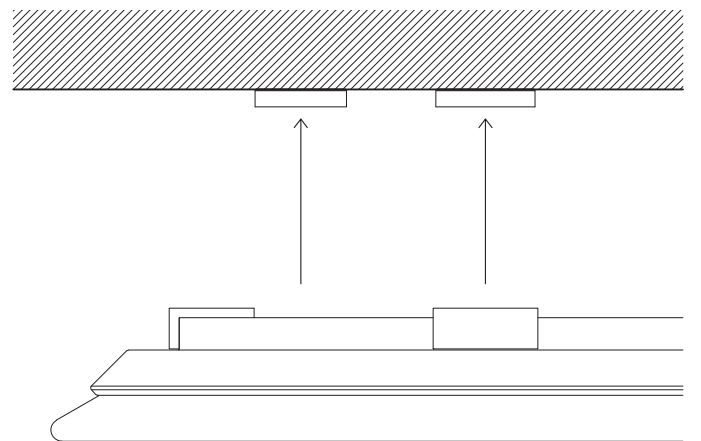

Allow for the dismantling of panels without tools.
Suitable for mounting on walls and ceilings.
Concealed/hidden solution.

Material: pot magnet, steel, aluminium

Overall depth of the panels from the face of the installation surface: 55 mm

Safety wire

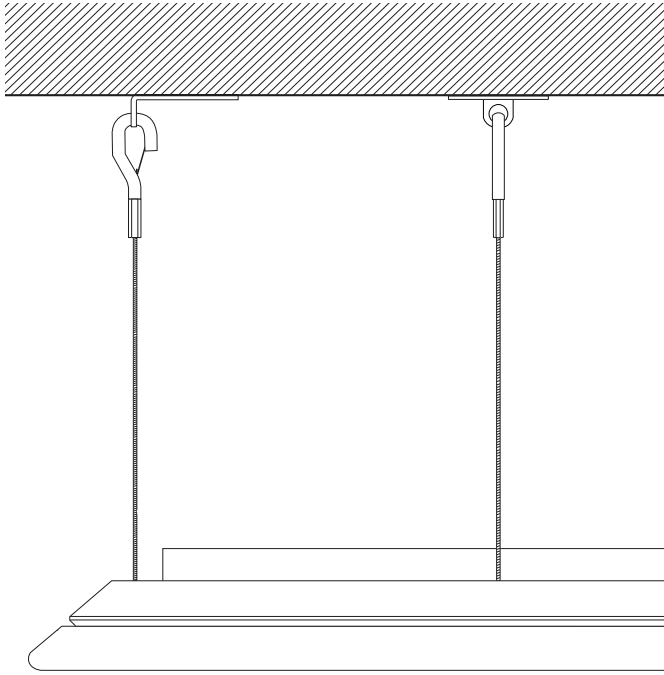

All suspension systems include safety wires if panels are installed in ceilings or on walls more than 3000 mm above floor level. (optional for wire suspension).

Fire performance

Kvadrat Soft Cells come with a range of fire tests classifications and certificates included as standard for several international markets (Europe, USA, China, Middle East, etc.). Due to the many different possible configurations of Soft Cells and varying fire regulations in different markets, the standard coverage can vary for your particular product choice and setting.

For further details please see Kvadrat Soft Cells fire performance, test certificates and services document.

CE-marking

Kvadrat Soft Cells comply with the EU-harmonised product standard for suspended ceilings (EN-13964)

For further details please refer to softcells.com

Printed SC

SC with print is available on Primus 1100 and Toto 1102 as a front textile.

Printed textiles are EN-fire tested B,s1-d0 and yields acoustic class A on Broadline.

Printed SC size limits are:

Max length of 3000 mm

Max width of 1500 mm.

End caps / closed edge

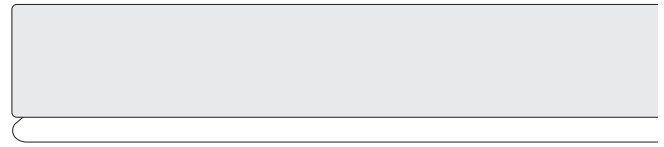

Front view End cap profile

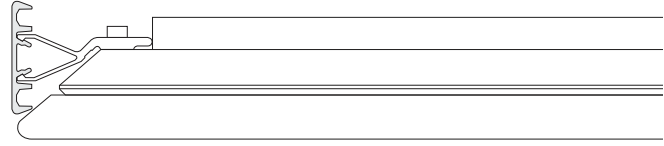

Side view End cap profile



Front view Closed edge profile

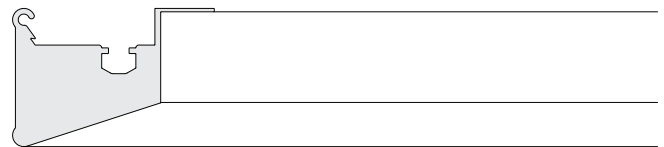

Section view Closed edge profile

For covering the small gap between wall and Soft Cells

Material: aluminium

Width of end cap: 45 mm, length adjusted to length or width of Soft Cells, max. 6000 mm in one piece
Can be either anodised surface or upholstered with the same textiles as the Soft Cells panels

For closed edge solution the front textile is upholstered over the closed edge to the back of the panel as an integrated solution (box)

Environmental labelling

Kvadrat Soft Cells carry general environmental product declaration (EPD) according to international standards. This information feed into all major environmental building certification schemes like DGNB, LEED, BREEAM, HQE and others used worldwide.

Furthermore, Kvadrat Soft Cells are designed for disassembly.

Acoustic performance

Acoustic results for specific textiles can be supplied upon request, or downloaded from soft-cells.com.

See indicative examples in figures below:

Wall Use

Wall and ceiling absorbers installed with magnets, 55 mm depth (ISO-354) with different front textiles

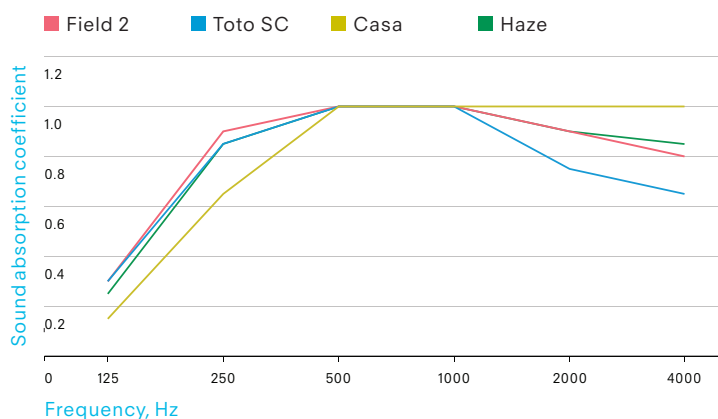

Ceiling Use

Suspended ceiling absorbers, 200 mm depth (ISO-354) with different front textiles

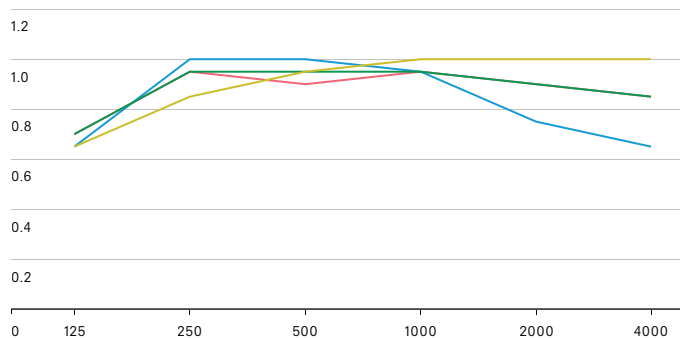

Textile example	Acoustic Class	α	EN Fire Class
Field 2	A	0,95	B-s1,d0
Ginger 2	A	0,95	B-s1,d0
Toto SC	B	0,80	B-s1,d0
Casa	A	0,95	B-s1,d0
Pro 3	A	1,00	B-s2,d0
Haze	A	0,95	B-s2,d0

Textile example	Acoustic Class	α	EN Fire Class
Field 2	A	0,95	B-s1,d0
Ginger 2	A	0,95	B-s1,d0
Toto SC	B	0,80	B-s1,d0
Casa	A	1,00	B-s1,d0
Pro 3	A	1,00	B-s2,d0
Haze	A	0,95	B-s2,d0